

URINAL CREATIV - FM

618121 100



Telefon : +45 5854 7217
info@bjornhammer.dk * www.bjornhammer.dk

Beskrivelse:

Væghængt urinal, fastgjort fra sanitetsrum. Tilslutning af vand på bagsiden med 1/2" gevind, forkromet spray-hoved og med 1 1/4" bundventil med buet rist. incl. vandlås Ø32 mm og monteringsbeslag og skruer.

Materiale:

- Rustfri stål 304, tykkelse på 1,2 mm og mat finish.

Mål:

- B 330 x D 372 x H 550 mm

Vandtilslutning:

- Tilslutning 1/2", afløb 1 1/4"
- Sifon Ø 32 mm
- Kan leveres med skyllesystemet Futura Flush - batteri / 220 V drift

Montering:

- Nem montering med S-clips, skruer og plugs, som er medleveret.

Norm:

- EN 13407:2015+A1:2018

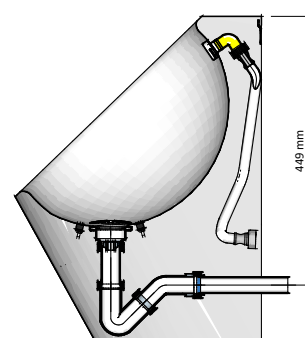
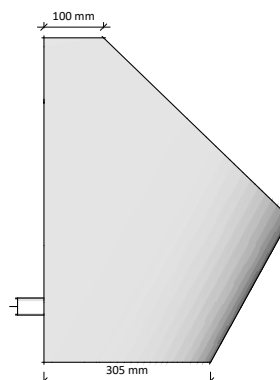
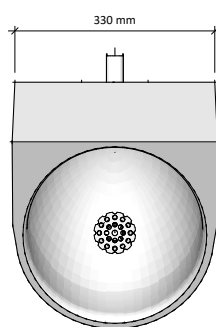
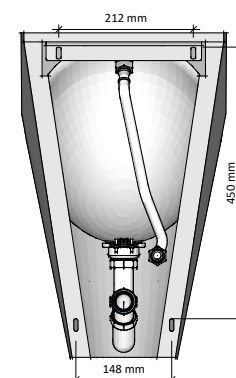
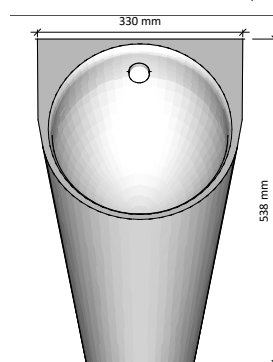
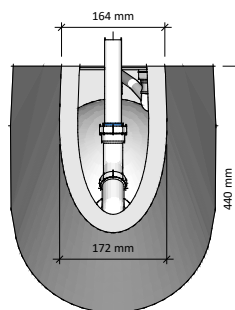

Særlige fordele:



Hygiejnisk



Opfylder CE norm

Loggere anbefaler :

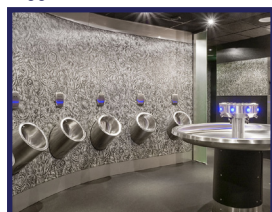

Sanitet



Skabe og skabssystemer



Sanitetskabiner



Garderobesystemer



Kontorenheder